

IN VENDITA PRESSO



PROMO **2014**  
PRIMAVERA / ESTATE  
SEMPRE PIÙ OFFERTE  
SOLO FINO AD AGOSTO

#PIÙ DI 350 PRODOTTI IN PROMOZIONE  
#75 NOVITÀ ASSOLUTE  
#4 SABBIA TRICHI IN SUPER PROMOZIONE  
#FERVI: QUALITÀ\_AFFIDABILITÀ\_SERVIZIO

TORNIO PARALLELO + BASE PER TORNIO

ART. 0716      ART. 0716/B



**VENDITA ABBINATA** €900,00 + IVA  
INVECE DI € 1.825,00 +IVA

	Altezza punte	90 mm
	Mandrino autocentrante 3+3	ø 100 mm
	Cono albero	CM / MT3

SABBIA TRICIA + MICROSFERE + GUANTI + PISTOLA PER SABBIARE + 4 UGELLI

ART. 0580      ART. 0581      ART. 0290



**VENDITA ABBINATA** €235,00 + IVA  
INVECE DI € 418,00 +IVA

	Dimensioni ingombro	630 x 510 x 490h mm
	Dimensioni utili interne	590 x 480 x 290h mm
	Pressione d'esercizio	6,5 - 7,5 bar

1 SCEGLI IL TUO PRODOTTO

2 VISUALIZZA IL QR CODE

3 GUARDA LE SPECIFICHE DEL PRODOTTO SUL SITO

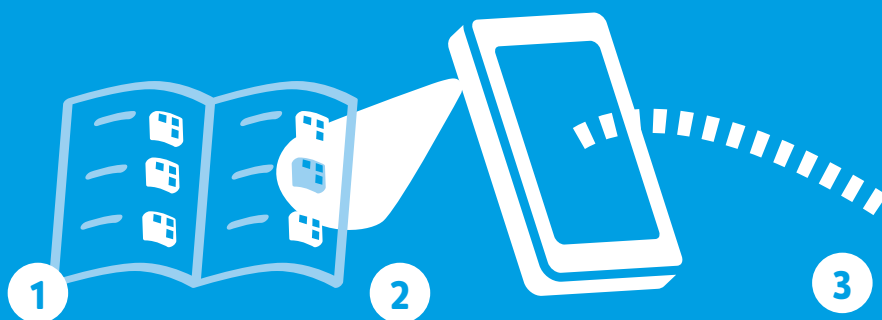

fervi.com



# MACCHINE E ACCESSORI

## TORNIO PARALLELO + BASE PER TORNIO

ART. 0708

ART. 0710



### VENDITA ABBINATA € 1.270,00 + IVA

INVECE DI € 2.240,00 + IVA



Dimensioni senza base	1080 x 440 x 400h mm
Altezza punte	110 mm
Distanza punte	520 mm

## TORNIO PARALLELO

ART. 0708



**€ 1.100,00**  
+ IVA

INVECE DI  
€ 1.950,00+IVA



Dimensioni senza base	1080 x 440 x 400h mm
Altezza punte	110 mm
Distanza punte	520 mm

## TORNIO PARALLELO

ART. 0716



**€ 730,00**  
+ IVA

INVECE DI  
€ 1.550,00+IVA



Altezza punte	90 mm
Mandrino autocentrante 3+3	ø 100 mm
Cono albero	CM / MT3

## TRAPANO FRESA DA BANCO AD INGRANAGGI

ART. T058



**€ 940,00**  
+ IVA

INVECE DI  
€ 1.490,00+IVA



Capacità di foratura con preforo	ø 13 mm
Capacità di fresatura con fresa cilindrica	ø 16 mm
Capacità di fresatura a manicotto	ø 30 mm

## TRAPANO A COLONNA

ART. T071



**€ 1.750,00**  
+ IVA

INVECE DI  
€ 2.780,00+IVA



Capacità di foratura con preforo	ø 28 mm
Cono morse	CM / MT 3
Corsa del mandrino	100 mm

## TRAPANO A COLONNA CON TRASMISSIONE A CINGHIA - 400 V

ART. 0754/400V



**€ 795,00**  
+ IVA

INVECE DI  
€ 1.250,00+IVA



Dimensioni tavola	475 x 425 mm
Mandrino	ø 20 mm B 22 CM / MT 4
Corsa mandrino	120 mm

**TRAPANO A COLONNA CON TRASMISSIONE A CINGHIA**

Codice	Morsa	Listino €	Netto €
0252/230V	120 x 155 mm	1.590,00	1.025,00
0252/400V	120 x 155 mm	1.590,00	1.025,00

**TRAPANO DA BANCO CON TRASMISSIONE A CINGHIA**
**ART. 0242**

**€ 455,00**  
+ IVA

 INVECE DI  
€ 760,00+IVA

Corsa mandrino	85 mm
Mandrino autoserrante	ø 16 mm, CM/MT 2
Dimensioni tavola	305 x 305 mm

**TRAPANO DA BANCO CON TRASMISSIONE A CINGHIA**
**ART. 0260**

**€ 352,50**  
+ IVA

 INVECE DI  
€ 580,00+IVA

Corsa mandrino	85 mm
Mandrino autoserrante	ø 13 mm, CM / MT 2
Dimensioni tavola	290 x 290 mm

**TRAPANO A COLONNA CON TRASMISSIONE A CINGHIA**
**ART. 0752**

**€ 465,00**  
+ IVA

 INVECE DI  
€ 770,00+IVA

Mandrino autoserrante	ø 16 mm B16 CM/MT 2
Corsa mandrino	80 mm
Altezza	1630 mm

**TRAPANO DA BANCO CON TRASMISSIONE A CINGHIA**
**ART. 0012**

**€ 285,00**  
+ IVA

 INVECE DI  
€ 480,00+IVA

Mandrino autoserrante	ø 16 mm CM / MT 2
Corsa mandrino	80 mm
Altezza	990 mm

**SEGATRICE A NASTRO PER METALLI**
**ART. 0255**

**€ 825,00**  
+ IVA

 INVECE DI  
€ 1.400,00+IVA

Dimensioni lama	1735 x 13 x 0,65 mm
Angolo di taglio	0 ÷ 60°
Velocità di taglio	34 m / min



# MACCHINE E ACCESSORI

## SEGATRICE A NASTRO

ART. 0362



€ 425,00  
+ IVA

INVECE DI  
€ 690,00+IVA



Dimensioni lama	1435 x 12,7 x 0,65 mm
Angolo di taglio	0° ÷ 60°
Motore	230 V 50 Hz 0,4 kW

## TRONCATRICE VELOCE

ART. 0642



€ 175,00  
+ IVA

INVECE DI  
€ 290,00+IVA



Velocità	3750 rpm
Dimensioni disco	350 x 2,7 x 25,4 mm
Motore	230 V 50 Hz 2,2 kW

## SMERIGLIATRICE DA BANCO CON LEVIGATRICE

ART. 0383



€ 92,50  
+ IVA

INVECE DI  
€ 150,00+IVA



Nastro	50 x 686 mm - grana 100
Mola	2950 rpm ø 150 x 20 x 16 mm
Motore	230 V 50 Hz 0,35 kW

## SMERIGLIATRICE DA BANCO PROFESSIONALE

ART. 0551



€ 103,00  
+ IVA

INVECE DI  
€ 170,00+IVA



Mola	2950 rpm - ø 150 x 20 x 16 mm
Motore	230 V 50 Hz 0,52 kW
Peso	16 Kg

## SMERIGLIATRICE DA BANCO PROFESSIONALE

ART. 0023



€ 48,00  
+ IVA

INVECE DI  
€ 85,00+IVA



Mola	2950 rpm - ø 150 x 20 x 12,7 mm
Motore	2950 rpm - 230 V 50 Hz 0,35 kW
Peso	7,8 Kg

## SMERIGLIATRICE DA BANCO PROFESSIONALE

ART. 0552



€ 163,00  
+ IVA

INVECE DI  
€ 268,00+IVA



Mola	2950 rpm - ø 200 x 25 x 20 mm
Motore	Monofase 230V 50Hz 0,9 kW
Peso	27 Kg

**SMERIGLIATRICE COMBINATA PROFESSIONALE CON ALBERI LUNGHI**
**ART. 0556**

**€ 123,00**  
+ IVA

 INVECE DI  
€ 210,00+IVA

<b>Spazzola</b>	2950 rpm - ø 200 x 25 x 20 mm
<b>Mola</b>	2950 rpm - ø 200 x 25 x 20 mm
<b>Motore monofase</b>	230 V 50 Hz 0,75 kW

**SMERIGLIATRICE COMBINATA PROFESSIONALE**

Codice	Spazzola	Listino €	Netto €
<b>0554</b>	2950 rpm ø 200 x 25 x 20 mm	<b>290,00</b>	<b>177,00</b>
<b>0554/400V</b>	2950 rpm ø 200 x 25 x 20 mm	<b>290,00</b>	<b>177,00</b>

**SMERIGLIATRICE COMBINATA**
**ART. 0377**

**€ 133,50**  
+ IVA

 INVECE DI  
€ 210,00+IVA

<b>Mola ad acqua</b>	130 rpm - ø 200 x 40 x 20 mm
<b>Mola a secco</b>	2950 rpm - ø 150 x 20 x 16 mm
<b>Motore monofase</b>	230 V 50 Hz 0,52 kW

**AFFILATRICE PER PUNTE ELICOIDALI**
**ART. A003/13**

**€ 435,00**  
+ IVA

 INVECE DI  
€ 700,00+IVA

<b>Capacità di affilatura</b>	3 ÷ 13 mm
<b>Inclinazione punta</b>	118° ÷ 135°
<b>Velocità</b>	7000 rpm

**LEVIGATRICE A NASTRO INCLINABILE CON BANCO + NASTRO ABRASIVO**
**ART. 0662**
**ART. N166**

**VENDITA ABBINATA € 341,50 + IVA**

INVECE DI € 583,80 +IVA



<b>Dimensioni nastro</b>	1219 x 152 mm
<b>Dimensioni disco</b>	ø 229 mm
<b>Dimensioni piano di lavoro</b>	330 x 152 mm

**MINI CALANDRA**
**ART. 0235**

**€ 120,00**  
+ IVA

 INVECE DI  
€ 190,00+IVA

<b>Lunghezza max</b>	300 mm
<b>Spessore max</b>	2,5 mm
<b>Diametro dei rulli</b>	30 mm



# MACCHINE E ACCESSORI

## MINI CESOIA - PIEGATRICE

ART. 0892



**€ 235,00**  
+ IVA

INVECE DI  
€ 380,00+IVA



Lavoro utile	200 mm
Max. spessore taglio su lamiera ferrosa	1 mm
Max. spessore piegatura su lamiera ferrosa	1 mm

## CURVATUBI IDRAULICO 1/2 - 2"

ART. 0893



**€ 292,50**  
+ IVA

INVECE DI  
€ 470,00+IVA



Matrici	1/2," 3/4," 1," 1-1/4," 1-1/2," 2," gas
Pressione massima	10 tons
Corsa pistone	250 mm

## PIEGAFERRI

ART. 0102



**€ 186,00**  
+ IVA

INVECE DI  
€ 300,00+IVA



Ferro dolce	A freddo / Cold
Tondino	22 mm
Piatto	100 x 8 mm

## CURVAFERRI

ART. 0113



**€ 185,00**  
+ IVA

INVECE DI  
€ 298,00+IVA



Ferro dolce	A freddo / Cold
Tondino	10 mm
Piatto	10 x 30 mm

## TORNIO DA LEGNO + MANDRINO AUTOCENTRANTE A 4 GRIFFE

ART. 0758

ART. 0425/125

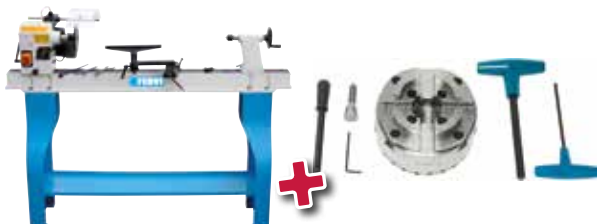

**VENDITA ABBINATA**

**€ 700,00 + IVA**

INVECE DI € 1.175,00 +IVA



Motore monofase	230 V 50 Hz 0,75 kW
Distanza tra le punte	1100 mm
Altezza punte	185 mm

## PIALLA FILO SPESSORE

ART. 0686/200



**€ 287,00**  
+ IVA

INVECE DI  
€ 490,00+IVA



Dimensioni piani	737 x 210 mm
Dimensioni	770 x 430 x 450h mm
Altezza piani	360 mm

**TRONCATRICE RADIALE PER LEGNO**
**ART. 0871**

**€ 335,00**  
+ IVA

 INVECE DI  
€ 530,00+IVA

Disco	ø 305 x 30 x 3,2 mm Z 40
Taglio massimo 0° - 90°	340 x 100 mm
Taglio massimo 45° - 90°	240 x 100 mm

**TRONCATRICE PER LEGNO**
**ART. 0275**

**€ 337,00**  
+ IVA

 INVECE DI  
€ 535,00+IVA

Disco	ø 315 x 30 x 3 mm Z 40
Taglio massimo 0° - 90°	100 x 170 mm
Taglio massimo 45° - 45°	62 x 118 mm

**TRONCATRICE PER LEGNO + SUPPORTO UNIVERSALE**
**ART. 0870/250**
**ART. 0365**

**VENDITA ABBINATA € 355,00 + IVA**

INVECE DI € 584,00 +IVA



Disco	ø 250 x 30 x 2,5 mm Z 36
Taglio massimo 0° - 90°	75 x 130 mm
Taglio massimo 45° - 45°	75 x 50 mm

**SEGA A NASTRO PER LEGNO**
**ART. 0717**

**€ 161,00**  
+ IVA

 INVECE DI  
€ 270,00+IVA

Volano	ø 200 mm
Lama	1430 x 6 x 0,36 mm T6
Capacità di taglio	190 x 85h mm

**SEGA A NASTRO PER LEGNO**
**ART. 0855**

**€ 571,00**  
+ IVA

 INVECE DI  
€ 890,00+IVA

Volano	ø 315 mm
Lama	2240 x 16 x 0,65 mm T4
Capacità di taglio	300 x 155h mm

**SEGA A NASTRO PER LEGNO**
**ART. 0764**

**€ 910,00**  
+ IVA

 INVECE DI  
€ 1.480,00+IVA

Volano	ø 405 mm
Capacità di taglio	350 x 200h mm
Lame	2950 x 16 x 0,65 mm T4



# MACCHINE E ACCESSORI

## LEVIGATRICE A NASTRO DA BANCO INCLINABILE

ART. 0505



**€ 139,00**  
+ IVA

INVECE DI  
€ 226,00+IVA



Dimensioni	460 x 380 x 270h mm
Nastro	914 x 100 mm
Disco	ø150 mm

## TAGLIA CORNICE

ART. 0720



**€ 28,50**  
+ IVA

INVECE DI  
€ 49,10+IVA



Altezza di taglio	110 mm
Larghezza di taglio	120 mm
Inclinazione di taglio	0° ±45°

## SPACCALEGNA VERTICALE

ART. S009



**€ 690,00**  
+ IVA

INVECE DI  
€ 1.300,00+IVA



Forza di spinta	7 ton
Capacità di lavoro in altezza	1040 / 780 / 520 mm
Capacità di lavoro	ø 50 ÷ 320 mm

## SABBIATRICE + CORINDONE GR. 80

ART. 0575

ART. 0582/80



**VENDITA ABBINATA € 445,00 + IVA**

INVECE DI € 775,00 + IVA



Dimensioni ingombro	890 x 560 x 1385h mm
Dimensioni utili interne	850 x 480 x 340 ÷ 540h mm
Pressione d'esercizio	6,5 ÷ 7,5 bar

## SABBIATRICE CON ASPIRATORE + CORINDONE BRUNO GR. 36

ART. 0687

ART. 0582/36



**VENDITA ABBINATA € 1.235,00 + IVA**

INVECE DI € 2.065,00 + IVA



Dimensioni ingombro	1220 x 910 x 1740h mm
Dimensioni utili interne	1200 x 600 x 600h mm
Pressione d'esercizio	6,5 ÷ 7,5 bar

## SABBIATRICE CON ASPIRATORE + CORINDONE BRUNO GR. 80

ART. 0878

ART. 0582/80



**VENDITA ABBINATA € 970,00 + IVA**

INVECE DI € 1.745,00 + IVA



Dimensioni ingombro	1030 x 850 x 1640h mm
Dimensioni utili interne	960 x 480 x 250 ÷ 470h mm
Pressione d'esercizio	6,5 ÷ 7,5 bar



### SABBIATRICE PER ESTERNO CON ASPIRATORE

ART. 0462



**€ 425,00**  
+ IVA

INVECE DI  
€ 720,00+IVA



Lunghezza tubi	2,5 m
Potenza	240 V 50 Hz 1,2 kW
Capacità di aspirazione	13÷15 kPa

### VASCA DI LAVAGGIO + LIQUIDO LAVAPEZZI

ART. 0038

ART. 0632/DA

ART. 0632/D



### VENDITA ABBINATA

**€ 320,00 + IVA**

INVECE DI € 542,00 +IVA



Dimensioni interne vasca	710 x 480 x 260h mm
Altezza	880 mm
Capacità	75 l

### POSTAZIONE SOFFIAGGIO

ART. 0435



**€ 140,00**  
+ IVA

INVECE DI  
€ 250,00+IVA



Dimensioni schermo	250 x 515 mm
Dimensioni cabina	560 x 545 x 630 mm
Alimentazione	230 V 50 Hz 10 W

### ASPIRATORE PER TRUCIOLI PARZIALMENTE MONTATO + SACCO FILTRAGGIO + 10 SACCHI IN PLASTICA

ART. 0756

ART. 0756/F

ART. 0756/S



### VENDITA ABBINATA

**€ 240,00 + IVA**

INVECE DI € 398,00 +IVA



Dimensioni	500 x 600 x 1700h mm
Diametro aspirazione	100 mm
Filtro in tessuto	Ø 370 mm

### ASPIRATORE PER TRUCIOLI PARZIALMENTE MONTATO + SACCO FILTRAGGIO + 10 SACCHI IN PLASTICA

ART. 0759

ART. 0759/F

ART. 0759/S



### VENDITA ABBINATA

**€ 380,00 + IVA**

INVECE DI € 651,10 +IVA



Dimensioni	840 x 560 x 1800h mm
Diametro aspirazione	2 x diam. 100 mm
Capacità filtrante	5 micron

### ASPIRAPOLVERE-LIQUIDO PER USO INDUSTRIALE COMPLETO DI ACCESSORI

ART. A030/30A



**€ 105,00**  
+ IVA

INVECE DI  
€ 180,00+IVA



Potenza	1,4 kW
Capienza	30 l
Motori	1 (230 V 50 Hz)



# MACCHINE E ACCESSORI

ASPIRAPOLVERE-LIQUIDO PER USO INDUSTRIALE COMPLETO DI ACCESSORI

ART. A030/60A



**€ 166,00**  
+ IVA

INVECE DI  
€ 290,00+IVA



Potenza	1,4 kW
Capienza	60 l
Motori	1 (230 V 50 Hz)

ASPIRAPOLVERE-LIQUIDO PER USO INDUSTRIALE COMPLETO DI ACCESSORI

ART. A030/80



**€ 335,00**  
+ IVA

INVECE DI  
€ 580,00+IVA



Potenza	3 kW
Capienza	80 l
Motori	3 (230 V 50 Hz)

PRESSA MANUALE

ART. P028/14



**€ 122,50**  
+ IVA

INVECE DI  
€ 195,00+IVA



Forza	200 Kg
Dimensioni	280 x 195 x 495h mm
Altezza max pezzo	280 mm

PRESSA MANUALE A CREMAGLIERA

ART. P029/3



**€ 228,00**  
+ IVA

INVECE DI  
€ 370,00+IVA



Forza	2500 Kg
Dimensioni	450 x 200 x 570h mm
Altezza max pezzo	290 mm

PRESSA MANUALE IDRAULICA

ART. P001/20



**€ 525,00**  
+ IVA

INVECE DI  
€ 890,00+IVA



Portata	20000 Kg
Area di lavoro	540 x 210 x 1000h mm
Ø del cilindro	70 mm

PRESSA MANUALE IDRAULICA

ART. P001/04



**€ 158,50**  
+ IVA

INVECE DI  
€ 260,00+IVA



Portata	4000 Kg
Area di lavoro	350 x 115 x 325h mm
Ø del cilindro	Ø 40 mm

### POMPA IDRAULICA

ART. 0271



**€ 67,00**  
+ IVA

INVECE DI  
€ 119,00+IVA



Pressione nominale	63,7 MPa
Capacità olio	790 ml
Dimensioni imballo	73 x 37,5 x 19 mm

### UNITÀ IDRAULICA IN KIT



Codice	Capacità	Listino €	Netto €
0054/10	10 Ton	330,00	192,50
0054/4	4 Ton	258,00	150,00

### TIRANTE IDRAULICO

ART. 0663



**€ 61,00**  
+ IVA

INVECE DI  
€ 110,00+IVA



Portata	5 T
Lunghezza Chiuso	560 mm
Lunghezza Aperto	690 mm

### CRIC A BOTTIGLIA



Codice	Portata	Listino €	Netto €
0062/2	2 Ton	22,00	12,50
0062/5	5 Ton	35,00	20,00
0062/10	10 Ton	47,00	29,00
0062/15	15 Ton	70,00	40,00
0062/20	20 Ton	80,00	48,00

### CRIC A BOTTIGLIA



Codice	Portata	Listino €	Netto €
0062/32	32 ton	155,00	70,00
0062/50	50 ton	268,00	145,00

### CRIC IDRAULICO A PROFILO RIBASSATO

ART. 0256/20



Portata max	20
Pressione d'esercizio	63.7 Mpa
Altezza min-max sollevabile	52 ÷ 63

**€ 54,00**  
+ IVA

INVECE DI  
€ 105,00+IVA



# MACCHINE E ACCESSORI

## CRIC A CARRELLO

ART. 0065



**€ 121,00**  
+ IVA

INVECE DI  
€ 199,00+IVA



Capacità	2,25 T
Dimensioni	660 x 350 x 170 mm
Alzata	145 ÷ 500 mm

## CRIC A PROFILO RIBASSATO

ART. 0369

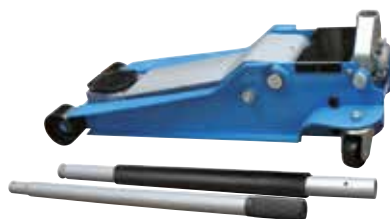

**€ 197,50**  
+ IVA

INVECE DI  
€ 298,00+IVA



Capacità	3,5 T
Dimensioni	745 x 335 x 180 mm
Alzata	110 ÷ 560 mm

## CRIC A CARRELLO

ART. 0060



**€ 36,00**  
+ IVA

INVECE DI  
€ 63,00+IVA



Capacità	2 T
Dimensioni	535 x 225 x 145 mm
Alzata	135 ÷ 385 mm

## CRIC A PROFILO RIBASSATO

ART. 0375



**€ 156,00**  
+ IVA

INVECE DI  
€ 256,00+IVA



Capacità	2 T
Dimensioni	790 x 285 x 180 mm
Alzata	90 ÷ 533 mm

## CRIC A CARRELLO

ART. 0788



**€ 265,00**  
+ IVA

INVECE DI  
€ 440,00+IVA



Capacità	1,5 T
Dimensioni	600 x 300 x 170 mm
Alzata	85 ÷ 445 mm

## CRIC A PROFILO RIBASSATO

ART. 0457



**€ 300,00**  
+ IVA

INVECE DI  
€ 500,00+IVA



Capacità	2000 Kg
Alzata	70 ÷ 500 mm
Dimensioni	785 x 350 x 152 mm

### COPPIA CAVALLETTI



Codice	Portata	Listino €	Netto €
0069/3	3 T	40,00	24,00
0069/6	6 T	75,00	45,50

### SOLLEVATORE IDRAULICO

ART. 0658



Capacità	10 T
Sollevamento sul piede	30 ÷ 260 mm
Sollevamento sulla testa	420 ÷ 650 mm

**€ 445,00**  
+ IVA

INVECE DI  
€ 775,00+IVA

### CARRELLO SPOSTA MOTO

ART. 0430



Portata max	300 Kg
Lunghezza	1929 mm
Peso	32,5 / 30 Kg

**€ 138,50**  
+ IVA

INVECE DI  
€ 226,00+IVA

### SOLLEVATORE IDRAULICO

ART. S008/M



Capacità di sollevamento	400 Kg
Dimensioni piattaforma	1825 x 660 mm
Lunghezza totale	2500 mm

**€ 480,00**  
+ IVA

INVECE DI  
€ 850,00+IVA

### CARRELLO REGOLABILE IN ALTEZZA

ART. 0010



Portata	500 Kg
Dimensioni tavola	850 x 500 x 50 mm
Alzata	290 ÷ 880 mm

**€ 450,00**  
+ IVA

INVECE DI  
€ 725,00+IVA

### CARRELLO REGOLABILE IN ALTEZZA

ART. 0075



Portata	300 Kg
Dimensioni tavola	850 x 500 x 50 mm
Alzata	290 ÷ 880 mm

**€ 415,00**  
+ IVA

INVECE DI  
€ 670,00+IVA



# MACCHINE E ACCESSORI

## CARRELLO REGOLABILE IN ALTEZZA

ART. 0467



**€ 525,00**  
+ IVA

INVECE DI  
€ 860,00+IVA



Portata	350 Kg
Dimensioni tavola	910 x 500 x 53 mm
Alzata	335 ÷ 1300 mm

## PARANCO A CATENA



Codice	Portata	Listino €	Netto €
0056/1	1000 Kg	130,00	80,00
0056/2	2000 Kg	192,00	125,00

## PARANCO A LEVA



Codice	Portata	Listino €	Netto €
0237/15	1500 Kg	240,00	147,50
0237/05	500 Kg	152,00	90,00

## PARANCO ELETTRICO

ART. 0600



**€ 162,50**  
+ IVA

INVECE DI  
€ 280,00+IVA



Portata	200 / 400 Kg
Lunghezza cavo	18 m
Velocità	8 m / min

## ARGANO ELETTRICO A 12 V IN CORRENTE CONTINUA

ART. 0630/0900



**€ 148,00**  
+ IVA

INVECE DI  
€ 275,00+IVA



Tiro massimo in linea orizzontale	450 Kg
Tiro nominale orizzontale	450 Kg
Velocità	1,3 - 3,2 m / min

## ARGANO ELETTRICO A 12 V IN CORRENTE CONTINUA

ART. 0630/2200



**€ 355,00**  
+ IVA

INVECE DI  
€ 700,00+IVA



Tiro massimo in linea orizzontale	2200 Kg
Tiro nominale orizzontale	2000 Kg
Velocità	1,5 - 3,6 m / min

### ARGANO MANUALE A FUNE



Codice	Tiro massimo	Listino €	Netto €
0791/16	1600 kg	450,00	243,00
0791/08	800 kg	330,00	165,00

### ARGANO ELETTRICO A 12 V IN CORRENTE CONTINUA

ART. 0630/2720



**€ 575,00**  
+ IVA

INVECE DI  
€ 952,00+IVA



Tiro massimo in linea orizzontale	2720 Kg
Tiro nominale orizzontale	2720 Kg
Velocità	1,3 - 4,5 m / min

### ARGANO MANUALE



Codice	Tiro massimo	Listino €	Netto €
0070	500 Kg	27,00	15,50
0070/C	500 Kg	38,00	23,00

### ARGANO MANUALE CON FRENO

ART. 0590



**€ 38,00**  
+ IVA

INVECE DI  
€ 62,00+IVA



Tiro massimo	450 Kg
Larghezza gola	49 mm
Diametro esterno rocchetto	110 mm

### SOLLEVATORE PER PALLETS

ART. S1/800



**€ 675,00**  
+ IVA

INVECE DI  
€ 1.050,00+IVA



Portata	1000 kg
Altezza forche	85 ÷ 800 mm
Dimensioni forche	1150 x 520 mm

### SOLLEVATORE CON PIATTAFORMA E FORCHE

ART. 0782



**€ 598,00**  
+ IVA

INVECE DI  
€ 990,00+IVA



Portata	400 Kg
Altezza forche	85 ÷ 1500 mm
Piattaforma	576 x 650 mm



# MACCHINE E ACCESSORI

## SOLLEVATORE PER PALLET CON FRENO E PEDALE DI SOLLEVAMENTO

ART. 0143



**€ 1.100,00**  
+ IVA

INVECE DI  
€ 1.690,00+IVA



Portata	1000 Kg
Altezza forche	90 ÷ 1600 mm
Dimensioni forche	1150 x 560 mm

## RAMPE IN ALLUMINIO



Codice	Dimensioni	Listino €	Netto €
0649/1500	1500 x 735 mm	320,00	207,00
0649/1800	1800 x 735 mm	390,00	238,00

## MORSA A MACCHINA CON BASE GIREVOLE 360°

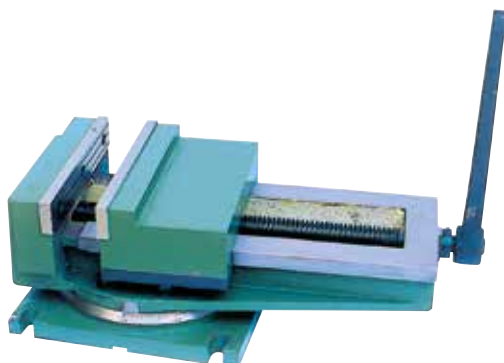

Codice	Ganasce mm	Listino €	Netto €
M023/125	125 x 40	230,00	115,00
M024/136	136 x 36	165,00	98,00
M024/160	160 x 50	240,00	132,00
M024/200	200 x 63	320,00	198,00
M024/250	250 x 63	460,00	269,00

## MORSA A MACCHINA CON BASE GIREVOLE 360°



Codice	Ganasce mm	Listino €	Netto €
M023/160	160 x 50	315,00	165,00
M023/200	200 x 63	395,00	234,00

## SERIE PARALLELE IN ACCIAIO

ART. P015



**€ 88,00**  
+ IVA

INVECE DI  
€ 160,00+IVA



Durezza	HRC 60
Precisione	± 0,005 mm
Pz	18

## SERIE PARALLELE IN ACCIAIO

ART. P014



**€ 150,00**  
+ IVA

INVECE DI  
€ 300,00+IVA



Durezza	HRC 60
Precisione	± 0,005 mm
Pz	28



### MORSA TRAPANO

ART. 0142/100



**€ 14,50**  
+ IVA

INVECE DI  
€ 24,30+IVA



Ganasce	100 x 25,5 mm
Interasse fori	125
Peso	2,8

### TAVOLA A CROCE

ART. T015/E



**€ 134,00**  
+ IVA

INVECE DI  
€ 250,00+IVA



A	100 mm
b	185 mm
C	130 mm

### TAVOLA A CROCE

ART. T008



**€ 160,00**  
+ IVA

INVECE DI  
€ 290,00+IVA



Dimensioni tavola	475 x 153 x 128h mm
Spostamenti	120 x 280 mm
Dimensioni base	200 x 270 mm

### TAVOLA BASCULANTE

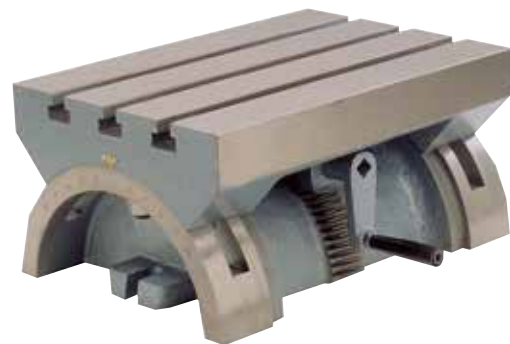

Codice	Dimensioni	Listino €	Netto €
T004/250	250 x 180 x 130h mm	375,00	195,00
T004/380	380 x 250 x 180h mm	575,00	320,00
T004/600	600 x 300 x 255h mm	990,00	595,00

### PIANO MAGNETICO



Codice	Dimensioni	Listino €	Netto €
P770/1	150 x 300 x 48h mm	615,00	380,00
P770/2	150 x 350 x 48h mm	715,00	445,00
P770/3	200 x 500 x 53h mm	1.470,00	915,00

### SET STAFFAGGIO



Codice	Cava	Listino €	Netto €
K001/12	12 mm	97,50	56,00
K001/14	14 mm	108,00	67,00
K001/16	16 mm	128,00	78,00
K001/18	18 mm	160,00	97,50



## MASCHIATORE A FRIZIONE REGISTRABILE CON INVERSIONE



Codice	Campo	Listino €	Netto €
M059/07	M 2 - 7	445,00	247,50
M059/12	M 5 - 12	510,00	295,00
M059/20	M 8 - 20	630,00	348,00

## CONTROPUNTA ROTANTE PER TUBI



Codice	CM	Listino €	Netto €
C055/3	3	188,00	112,50
C055/4	4	268,00	155,00

## MANDRINO AUTOCENTRANTE DI PRECISIONE



Codice	D	Listino €	Netto €
M049/100	100 mm	170,00	96,00
M049/125	125 mm	180,00	110,00
M049/160	160 mm	240,00	150,00
M049/200	200 mm	335,00	205,00
M049/250	250 mm	390,00	235,00

## MANDRINO AUTOCENTRANTE



Codice	D1	Listino €	Netto €
M449/100	72 mm	180,00	99,00
M449/125	95 mm	210,00	112,50
M449/160	130 mm	260,00	156,00
M449/250	206 mm	484,00	290,00
M449/200	165 mm	378,00	227,00

## SMONTA MANDRINO



Codice	Mandrino	Listino €	Netto €
S014/40BT	BT 40 ISO 40	70,00	40,00
S014/40DIN	DIN 69871.40 ISO 40	70,00	40,00
S014/50DIN	DIN 69871.50 ISO 50	160,00	92,00
S014/50BT	BT 50 ISO 50	160,00	92,00

## UTENSILE PER ESTERNO CON INSERTI



Codice	Contenuto del set	Listino €	Netto €
KITCKJ20	CKJNR20 + 10 KNUX160405RN	170,00	70,00
KITCKJ25	CKJNR25 + 10 KNUX160405RN	172,00	78,50

### SET UTENSILI PER INTERNO 95°

ART. KISCLCR



**€ 115,00**  
+ IVA

INVECE DI  
€ 230,00+IVA



1 Pezzo	SCLCR08; SCLCR10; SCLCR12; SCLCR16
1 Pezzo	Vite T8 Ø 2,5 mm
10 Pezzi	CCMT060204N

### SET UTENSILI PER INTERNO 90°

ART. KISTCMT



**€ 140,00**  
+ IVA

INVECE DI  
€ 250,00+IVA



1 Pezzo	STFCR10; STFCR12; STFCR16; STFCR20
1 Pezzo	Vite T8 Ø 2,5 mm
10 Pezzi	TCMT110204N

### KIT FILETTATURA PER ESTERNO

ART. KISER25



**€ 127,00**  
+ IVA

INVECE DI  
€ 220,00+IVA



Stelo	25 x 25 mm
L	150 mm
Inserto	16ER...

### SET PER CANALINI ESTERNI ED INTERNI

ART. KICAN



**€ 132,50**  
+ IVA

INVECE DI  
€ 214,00+IVA



Utensile per esterno	20 x 20 mm
Utensile per interno	Ø 20 mm
Inserti	1,1-1,3-1,6-1,85-2,15-2,65-3,15 mm

### KIT FILETTATURA PER INTERNO

ART. KISNR25



**€ 140,00**  
+ IVA

INVECE DI  
€ 229,00+IVA



Ø	25 mm
h	23 mm
L	200 mm

### LAMPADA ALOGENA PER MACCHINE UTENSILI

ART. 0532



**€ 102,50**  
+ IVA

INVECE DI  
€ 190,00+IVA



Alimentazione	24V 50W
Altezza	890 mm
Diametro	125 mm



## SET UTENSILI BRASATI



Codice	Kit	Listino €	Netto €
B005	1BRAS411108RP	25,00	13,00
	1BRAS411110RP		
	1BRAS410312RP		
	1BRAS410412RP		
	1BRAS410912RP		
B005/16	1BRAS411110RP	37,50	22,00
B005/20	1BRAS411112RP	47,00	31,00
	1BRAS411116RP		
	1BRAS410320RP		
	1BRAS410420RP		
	1BRAS410920RP		



## SERIE PUNTE RETTIFICATE AFFILATE 135° AUTOCENTRANTI

P069



**€ 74,00**  
+ IVA

INVECE DI  
€ 128,00 +IVA



Misura (progressione 0,5)	1÷13 mm
Pezzi	25

## SERIE PUNTE RETTIFICATE AFFILATE 135° AUTOCENTRANTI

P067



**€ 37,00**  
+ IVA

INVECE DI  
€ 65,00 +IVA



Misura (progressione 0,5)	1÷10 mm
Pezzi	19

## SERIE PUNTE RETTIFICATE E AUTOCENTRANTI

P062



**€ 35,00**  
+ IVA

INVECE DI  
€ 65,00 +IVA



Misura (progressione 0,5)	1÷13 mm
Pezzi	25

## FRESA A SCALINI

F238



**€ 41,50**  
+ IVA

INVECE DI  
€ 75,00 +IVA



Gambo	10 mm
Ø	2,5 ÷ 38 (2,5-6,3-13-16-19-21-23-26-29-32-35-38)

## SERIE LAMATORI TIPO MEDIO CON ATTACCO CILINDRICO

L020



**€ 55,00**  
+ IVA

INVECE DI  
€ 95,00 +IVA



Per viti	M 3 - 4 - 5 - 6 - 8 - 10 - 12
----------	-------------------------------

### SERIE MASCHI PER FORI CIECHI 35° GAMBO RINFORZATO

M312/C



€ 34,00  
+ IVA

INVECE DI  
€ 62,50 +IVA



**Misura** M3 x 0,50 - M4 x 0,70 - M5 x 0,80 -  
M6 x 1 - M8 x 1,25 - M10 x 1,50 - M12 x 1,75  
**Accessorio** Giramaschio

### SERIE MASCHI PER FORI PASSANTI GAMBO RINFORZATO

M312/P



€ 32,50  
+ IVA

INVECE DI  
€ 57,50 +IVA



**Misura** M3 x 0,50 - M4 x 0,70 - M5 x 0,80  
M6 x 1 - M8 x 1,25 - M10 x 1,50 - M12 x 1,75  
**Accessorio** Giramaschio

### SET MASCHI E FILIERE IN ACCIAIO AL TUNGSTENO

M218



€ 140,00  
+ IVA

INVECE DI  
€ 226,00 +IVA



**M 2 ÷ 18** 110 Pz / Pcs  
**Maschi a mano serie 2pz e filiera**  
M2x0,40 M9x1 M12x1,25 M3x0,50 M9x1,25  
M12x1,5 M4x0,70 M10x0,75 M12x1,75  
M5x0,80 M10x1 M14x1 M6x0,75 M10x1,25  
M14x1,25 M6x1 M10x1,5 M14x1,5 M7x0,75  
M11x0,75 M14x2 M7x1 M11x1 M16x1  
M8x0,75 M11x1,25 M16x1,5 M8x1 ...

### SET MASCHI E FILIERE IN ACCIAIO AL TUNGSTENO

M100



€ 80,00  
+ IVA

INVECE DI  
€ 140,00 +IVA



**M 6 ÷ 24** 45 Pz / Pcs  
**Accessori** 1 Giramaschio - 1 Girafiliera  
**Maschio a mano e filiera**  
M6x0,75 - M16x1,5 - M6x1 - M16x2 -  
M8x1 - M18x1,5 - M8x1,25 - M18x2,5 -  
M10x1,25 - M20x1,5 - M10x1,5 -  
M20x2,5 - M12x1,5 - M22x1,5 - M12x1,75 -  
M22x2,5 - M14x1,5 - M24x1,5 - M14x2 -  
M24x3

### KIT RIPARAZIONE FILETTI M5 - M12 INOX

E010



€ 75,00  
+ IVA

INVECE DI  
€ 130,00 +IVA



**Contenuto del set**  
**Manici a "T"** 5 Pz / 5 Pcs  
**Filetto** M5=25 M6=25 M8=25 M10=25 M12=10

### INGRASSATORE MANUALE

0677



€ 21,00  
+ IVA

INVECE DI  
€ 35,00 +IVA



**Capacità** 1000 cc  
**Dimensioni tubo flessibile** Ø 9 x 450 mm  
**Peso** 2 kg

IN VENDITA PRESSO



PROMO **2014**  
PRIMAVERA / ESTATE  
SEMPRE PIÙ OFFERTE  
SOLO FINO AD AGOSTO

#PIÙ DI 350 PRODOTTI IN PROMOZIONE  
#75 NOVITÀ ASSOLUTE  
#SPECIALE UTENSILERIA  
#FERVI: QUALITÀ\_AFFIDABILITÀ\_SERVIZIO

SERIE CHIAVI COMBinate CON TESTA A CRICCHETTO SNODATA

0690/12P



€ 76,20  
+ IVA

INVECE DI  
€ 160,00 +IVA



Pz 12  
Misure 8 - 9 - 10 - 11 - 12 - 13 - 14 - 15 - 16 - 17 - 18 - 19 mm

SERIE CHIAVI COMBinate CON TESTA A CRICCHETTO SNODATA

0690/07P



€ 52,50  
+ IVA

INVECE DI  
€ 99,00 +IVA



Pz 7  
Misure ø 8 - 10 - 11 - 13 - 15 - 17 - 19 mm

- 1 SCEGLI IL TUO PRODOTTO
- 2 VISUALIZZA IL QR CODE
- 3 GUARDA LE SPECIFICHE DEL PRODOTTO SUL SITO

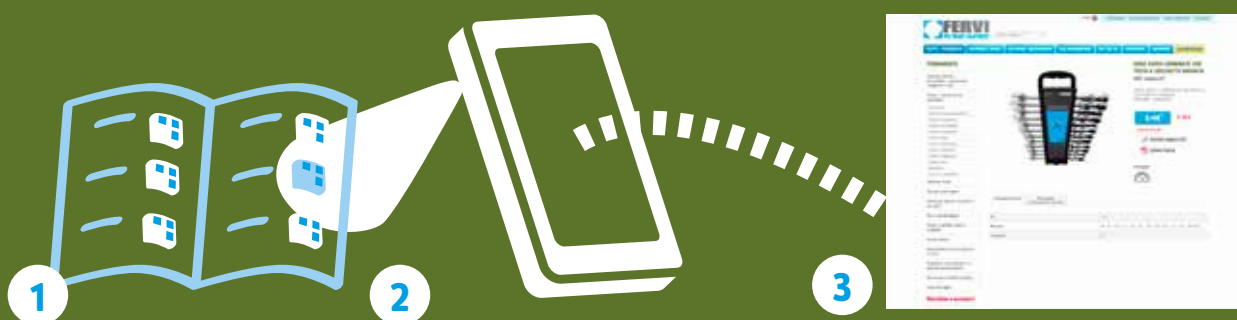

SE TI SERVE CE L'ABBIAMO, SE NON SAI COSA TI SERVE... PARLIAMONE!

fervi.com



## SET DI CHIAVI FISSE CROMATE, LUCIDATE A SPECCHIO

0201



**€ 29,50**  
+ IVA

INVECE DI  
€ 70,00 +IVA



<b>Serie</b>	6÷ 32
<b>Misura</b>	6x7 8x9 10x11 12x13 14x15 16x17 18x19 20x22 21x23 24x27 25x28 30x32 mm
<b>Pz</b>	12

## SET DI CHIAVI FISSE CROMATE, LUCIDATE A SPECCHIO

0208



**€ 62,50**  
+ IVA

INVECE DI  
€ 120,00 +IVA



<b>Serie</b>	6÷ 32
<b>Misura</b>	6-7-8-9-10-11-12-13-14-15-16-17-18-19-20- 21-22-23-24-25-26-27-28-30-32 mm
<b>Pz</b>	25

## SET DI CHIAVI FISSE CROMATE, LUCIDATE A SPECCHIO



Codice	Serie	Listino €	Netto €
0199	6÷ 22	50,00	23,90
0199P	1/4÷ 1"	59,00	34,00

## SERIE CHIAVI COMBinate

0223



**€ 40,00**  
+ IVA

INVECE DI  
€ 68,00 +IVA



<b>Serie</b>	6÷ 32
<b>Pz</b>	25
<b>Misura</b>	6-7-8-9-10-11-12-13-14-15-16-17-18-19- 20-21-22-23-24-25-26-27-28-30-32 mm

## SERIE CHIAVI FISSE

0222



**€ 19,50**  
+ IVA

INVECE DI  
€ 38,00 +IVA



<b>Serie</b>	6÷ 32
<b>Misura</b>	6x7 8x9 10x11 12x13 14x15 16x17 18x19 20x22 21x23 24x27 25x28 30x32 mm
<b>Pz</b>	12

## SET CHIAVI A TUBO ESAGONALI 8PZ

0442



**€ 47,50**  
+ IVA

INVECE DI  
€ 80,00 +IVA



<b>Dimensioni</b>	105 x 6 x 7 mm, 110 x 8 x 9 mm, 120 x 10 x 11 mm, 140 x 12 x 13 mm, 145 x 14 x 15 mm, 155 x 16 x 17 mm, 165 x 18 x 19 mm, 170 x 20 x 22 mm
-------------------	-----------------------------------------------------------------------------------------------------------------------------------------------------

### SET 15 PZ CHIAVI PER FILTRI OLIO



Codice	Attacco chiavi	Listino €	Netto €
0018/15	3/8"	58,00	32,50
0018/30	3/8"	130,00	75,00

### CHIAVE A CROCE



Codice	Misure	Listino €	Netto €
0426/30	24 x 27 x 30 mm - 3/4"	30,00	17,50
0426/32	24 x 27 x 32 mm - 3/4"	38,00	21,50

### CHIAVE A CROCE SMONTABILE

0451



**€ 19,00**  
+ IVA

INVECE DI  
€ 32,00 +IVA



Attacco quadro	1/2"
Misure bussole	17-19-21-23 mm
Dimensioni leva	Ø15 x 400 mm

### SET CHIAVI ESAGONALI MASCHIO A "T"

0400



**€ 38,50**  
+ IVA

INVECE DI  
€ 60,00 +IVA



Contenuto del set	2 - 3 - 4 - 5 - 6 - 8 - 10 mm
Materiale	Cromo Vanadio

### SET CHIAVI TORX MASCHIO A "T"

0405



**€ 39,00**  
+ IVA

INVECE DI  
€ 64,00 +IVA



Contenuto del set	T8-T9-T10-T15-T20-T25-T30
Materiale	Cromo Vanadio

### CHIAVE DINAMOMETRICA DIGITALE

0268



**€ 50,00**  
+ IVA

INVECE DI  
€ 84,00 +IVA



SCALE DI MISURAZIONE:	Nm/kgm/kgcm/lbft/lbin
Capacità	40÷ 200 Nm
Letture	0,1 Nm





# FERRAMENTA

## CACCIAVITE DINAMOMETRICO DIGITALE

0806/020



**€ 59,50**  
+ IVA

INVECE DI  
€ 98,00 +IVA



<b>SCALE DI MISURAZIONE:</b>	Nm/kgm/lbft/lbin
<b>Capacità</b>	0÷ 20 Nm
<b>Lettura</b>	0,01 Nm

## CHIAVI DINAMOMETRICHE



Codice	Capacità	Listino €	Netto €
0803/210	40 - 210 Nm	180,00	92,00
0803/110	19 - 110 Nm	125,00	65,50

## MOLTIPLICATORE DI FORZA, SMONTARUOTE PER AUTOCARRO

0329



**€ 77,00**  
+ IVA

INVECE DI  
€ 155,00 +IVA



<b>Bussole 1"</b>	32 - 33 mm
<b>Rapporto</b>	1:60
<b>Forza massima</b>	3200 Nm

## CHIAVE DINAMOMETRICA IN SET 11 PZ

0803/S210



**€ 155,00**  
+ IVA

INVECE DI  
€ 290,00 +IVA



<b>Capacità</b>	40 - 210 Nm
<b>Precisione</b>	±4%
<b>Chiavi</b>	13 - 14 - 15 - 17 - 19 - 22 - 24 - 27 - 30 mm

## CRICCHETTO ERGONOMICO



Codice	Attacco quadro	Listino €	Netto €
0439/1/2	1/2"	29,00	11,90
0439/1/4	1/4"	19,00	6,90
0439/3/8	3/8"	24,00	9,00

## CRICCHETTO REVERSIBILE A CAMBIO RAPIDO 3 IN 1

CN450N0/0



**€ 26,00**  
+ IVA

INVECE DI  
€ 45,00 +IVA



<b>Attacco</b>	1/2", 3/8", 1/4"
<b>Lunghezza</b>	230 mm
<b>Denti</b>	72

### CRICCHETTO ERGONOMICO A 72 DENTI TESTA RIDOTTA



Codice	Attacco quadro	Listino €	Netto €
0440/1/2	1/2"	28,00	10,50
0440/3/8	3/8"	23,00	7,50
0440/1/4	1/4"	18,00	5,90

### SET 13 PZ BUSSOLE POLIGONALI A BASSO PROFILO

SN4E4C013



Attacco quadro	3/8"
Bussole	8, 9, 10, 11, 12, 13, 14, 15, 16, 17, 18, 19 mm

**€ 51,00**  
+ IVA

INVECE DI  
€ 85,00 +IVA

### SET 15 PZ BUSSOLE PROFILO RIBASSATO

SN4E3C015



Attacco quadro	1/2"
Bussole	8, 10, 11, 12, 13, 14, 15, 17, 18, 19, 21, 22, 23, 24 mm

**€ 65,50**  
+ IVA

INVECE DI  
€ 109,00 +IVA

### SERIE CHIAVI A PIPA ESAGONALI

0393



Misure	ø 6 - 7 - 8 - 10 - 11 - 12 - 13 - 14 - 17 - 19 - 22 mm
--------	--------------------------------------------------------

**€ 44,00**  
+ IVA

INVECE DI  
€ 69,00 +IVA

### SERIE 46 PZ CHIAVI A BUSSOLA ESAGONALI DA 1/4"

0624



Attacco	1/4"
Pezzi	46
Cromo Vanadio	

**€ 37,50**  
+ IVA

INVECE DI  
€ 59,00 +IVA

### SERIE 94 PZ CHIAVI A BUSSOLA ESAGONALI DA 1/4" E 1/2"

0618



Attacco	1/2" - 1/4"
Pezzi	94
Cromo Vanadio	

**€ 95,00**  
+ IVA

INVECE DI  
€ 175,00 +IVA



## SERIE 20PZ CHIAVI A BUSSOLA DA 3/4"

0181



**€ 77,50**  
+ IVA

INVECE DI  
€ 140,00 +IVA



<b>Attacco</b>	3/4"
<b>Misure</b>	19 - 21 - 22 - 23 - 24 - 26 - 27 - 30 - 32 - 34 - 36 - 38 - 41 - 46 - 48 - 50 mm

## SET 13 BUSSOLE AD IMPATTO, SERIE NORMALE

SI4E3N013

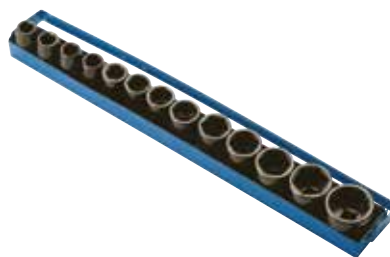

**€ 24,50**  
+ IVA

INVECE DI  
€ 65,00 +IVA



<b>Attacco quadro</b>	1/2"
<b>Bussole</b>	10, 11, 12, 13, 14, 16, 17, 19, 21, 22, 24, 27, 30 mm

## PROLUNGA A SGANCIO RAPIDO AD IMPATTO



Codice	Attacco	Listino €	Netto €
PI453075	1/2"	18,00	10,00
PI453150	1/2"	19,50	10,50
PI453250	1/2"	22,00	12,00

## SERIE 3 CHIAVI BUSSOLA ESAGONALI IMPACT RIVESTITE IN PLASTICA

0341



**€ 19,00**  
+ IVA

INVECE DI  
€ 32,00 +IVA



<b>Attacco</b>	1/2"
<b>Misure</b>	17 - 19 - 21 mm
<b>Lunghezza</b>	87 mm

## SET 8 BUSSOLE AD IMPATTO, SERIE NORMALE

SI4E2N008



**€ 55,00**  
+ IVA

INVECE DI  
€ 96,00 +IVA



<b>Attacco quadro</b>	3/4"
<b>Bussole</b>	26, 27, 29, 30, 32, 35, 36, 38 mm

## SET 8 BUSSOLE AD IMPATTO

SI4E1N008



**€ 78,50**  
+ IVA

INVECE DI  
€ 143,00 +IVA



<b>Attacco quadro</b>	1"
<b>Bussole</b>	24, 27, 30, 32, 33, 36, 38, 41 mm

### SET 41 PZ INSERTI ESAGONALI

0402



**€ 10,00**  
+ IVA

INVECE DI  
€ 16,00 +IVA



Attacco	1/4"
Taglio	3 - 4 - 5 - 5,5 - 6 - 7 mm
Phillips	2 x 0 - 2 x 1 - 2 x 2 - 2 x 3

### PINZA LUNGA A DOPPIO FULCRO A 45°

0872/P



**€ 31,50**  
+ IVA

INVECE DI  
€ 60,00 +IVA



Lunghezza	340 mm
Lunghezza	300 mm

### PINZA LUNGA A DOPPIO FULCRO

0872/OPD



**€ 14,00**  
+ IVA

INVECE DI  
€ 23,00 +IVA



Lunghezza	335 mm
Spessore	11 mm
Peso	450 g

### PINZA LUNGA A DOPPIO FULCRO A 45°

0872/PCD



**€ 13,00**  
+ IVA

INVECE DI  
€ 22,00 +IVA



Lunghezza	335 mm
Spessore	11 mm
Peso	390 g

### PINZA LUNGA A DOPPIO FULCRO DRITTA

0872/PDD



**€ 13,00**  
+ IVA

INVECE DI  
€ 22,00 +IVA



Lunghezza	335 mm
Spessore	11 mm
Peso	390 g

### RIVETTATRICE A DOPPIA LEVA PER INSERTI FILETTATI

0455



**€ 52,50**  
+ IVA

INVECE DI  
€ 90,00 +IVA



Tiranti filettati	M3 - M4 - M5 - M6 - M8 - M10 - M12
Lunghezza	400 mm



# FERRAMENTA

## RIVETTATRICE PER INSERTI FILETTATI

0469



€ 29,50  
+ IVA

INVECE DI  
€ 50,00 +IVA



Tiranti filettati	M3 - M4 - M5 - M6
Lunghezza	200 mm

## RIVETTATRICE A DOPPIA LEVA

0453



€ 22,00  
+ IVA

INVECE DI  
€ 40,00 +IVA



Rivetti	Ø 3,2 - 4,0 - 4,8 - 6,4 mm
Lunghezza	400 mm

## RIVETTATRICE A DOPPIA LEVA A CAMBIO RAPIDO

0454



€ 24,50  
+ IVA

INVECE DI  
€ 45,00 +IVA



Rivetti	Ø 3,2 - 4,0 - 4,8 - 6,4 mm
Lunghezza	400 mm

## RIVETTATRICE A CAMBIO RAPIDO

0470



€ 9,30  
+ IVA

INVECE DI  
€ 16,00 +IVA



Rivetti	2,4 mm - 3 / 32", 3,2 mm - 1 / 8", 4,0 mm 5 / 32", 4,8 mm - 3 / 16"
---------	------------------------------------------------------------------------

## BORDATUBO PER RAME E ALLUMINIO

0472



€ 9,50  
+ IVA

INVECE DI  
€ 16,00 +IVA



Diametro tubi	Ø5 - 6 - 8 - 10 - 12 - 14 - 16 mm
Peso	750 g

## BACINELLA PER CAMBIO OLIO



Codice	Capacità	Listino €	Netto €
0473/10	10 l	17,50	11,00
0473/15	15 l	19,00	11,50

### TANICA IN METALLO



Codice	Capacità Litri	Listino €	Netto €
0189/05C	5	35,00	17,00
0189/10C	10	38,00	19,00
0189/20C	20	45,00	20,90

### POMPA A LEVA PER FUSTI OLIO LUBRIFICANTE

0386



**€ 22,50**  
+ IVA

INVECE DI  
€ 35,00 +IVA



Portata	18 l/min
Filetto pompa	2" / 1-1/2"
Peso	2 kg

### PISTOLA PER TRAVASO GASOLIO IN ALLUMINIO

0474/PE



**€ 16,00**  
+ IVA

INVECE DI  
€ 25,00 +IVA



Portata	60÷120 l/min
Boccaglio	ø25 mm
Peso	0,80 kg

### PISTOLA PER TRAVASO GASOLIO IN PVC

0474/PP



**€ 9,00**  
+ IVA

INVECE DI  
€ 14,00 +IVA



Portata	60÷80 l/min
Boccaglio	ø25 mm
Peso	0,8 kg

### PISTOLA PER TRAVASO GASOLIO AUTOMATICA

0474/PA



**€ 37,50**  
+ IVA

INVECE DI  
€ 68,00 +IVA



Portata	90 l/min
Boccaglio	ø25 mm
Peso	1,4 kg

### MORSA DA BANCO IN GHISA

0174/100



**€ 27,00**  
+ IVA

INVECE DI  
€ 50,00 +IVA



Ganasce	100 x 12 mm
Apertura	100 mm
Peso	4,8 Kg



## MORSA GIREVOLE CON MORSETTO

0146/60



**€ 12,00**  
+ IVA

INVECE DI  
€ 22,00 +IVA



Ganascia	60 mm
Apertura	50 mm
Capacità morsetto	45 mm

## MORSA IN ACCIAIO CON STRINGITUBO



Codice	Ganascia	Listino €	Netto €
0145/80	80 mm	31,50	16,00
0145/125	125 mm	51,00	25,50

## MORSA PARALLELA DA BANCO CON GUIDE PRISMATICHE



Codice	Ganasce	Listino €	Netto €
0427/080	80 mm	69,00	43,00
0427/100	100 mm	89,00	55,00
0427/125	125 mm	119,00	75,00

## MORSA IN ACCIAIO



Codice	Ganascia	Listino €	Netto €
0036/100	100 mm	102,00	57,00
0036/125	125 mm	138,00	80,00
0036/150	150 mm	230,00	140,00

## MORSA IN ACCIAIO GIREVOLE



Codice	Ganascia	Listino €	Netto €
0036/100G	100 mm	120,00	65,00
0036/125G	125 mm	165,00	100,00

## MORSA IN ACCIAIO

0591/100



**€ 82,00**  
+ IVA

INVECE DI  
€ 135,00 +IVA



Ganascia	100 mm
Apertura	105 mm
Peso	6,1 Kg

### INCUDINI IN ACCIAIO INDURITO C45

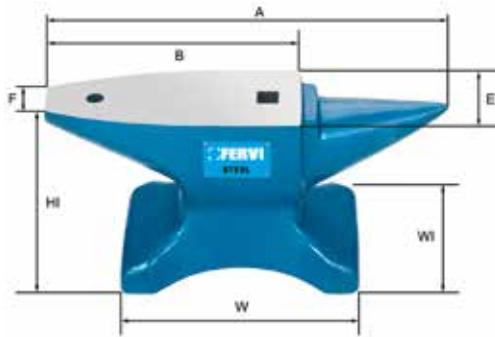

Codice	A	Listino €	Netto €
0157/10	265 mm	90,00	55,00
0157/30	400 mm	225,00	138,00
0157/50	530 mm	348,00	218,00
0157/100	635 mm	750,00	455,00

### TAGLIABULLONI



Codice	Dimensioni	Listino €	Netto €
0287/300	300 mm - 12"	14,50	8,50
0287/350	350 mm - 14"	16,00	9,75
0287/450	450 mm - 18"	21,20	12,50
0287/600	600 mm - 24"	27,00	13,80
0287/750	750 mm - 30"	35,00	19,00

### BANCO DA LAVORO IN FERRO IN KIT DI MONTAGGIO

**B015**



**€ 300,00**  
+ IVA

INVECE DI  
€ 480,00 +IVA



Dimensioni banco	1500 x 640 x 865h mm
Spessore gambe	1,0 mm
Spessore piano	2 mm

### BANCO CHIUDIBILE IN ACCIAIO

**B019**



**€ 305,00**  
+ IVA

INVECE DI  
€ 490,00 +IVA



Dimensioni piano	1195 x 648 x 41 mm
Portata	225 kg
Peso	47 kg

### BANCO DA LAVORO IN KIT DI MONTAGGIO

**B017**



**€ 200,00**  
+ IVA

INVECE DI  
€ 320,00 +IVA



Dimensioni banco	1524 x 650 x 845h mm
Spessore gambe	1,0 mm
Spessore piano	40 mm

### CASSETTO IN ACCIAIO CON SERRATURA

**B017/C**



**€ 39,00**  
+ IVA

INVECE DI  
€ 62,00 +IVA



Dimensioni	680 x 270 x 130 mm
Portata	18,5 kg
Peso	4,3 kg





## ARMADIETTO

A300



**€ 240,00**  
+ IVA

INVECE DI  
€ 390,00 +IVA



Dimensioni armadietto	1000 x 460 x 1000h mm
Spessore lamiera	1 mm
Ripiani interni	2

## VALIGETTA PORTAMINUTERIA



Codice	Dimensioni	Listino €	Netto €
0423/1	334 x 240 x 45 mm	28,00	16,50
0423/2	388 x 295 x 45 mm	33,00	20,00

## CASSETTIERA CON 4 VALIGETTE PORTA MINUTERIA

C313



**€ 40,00**  
+ IVA

INVECE DI  
€ 63,50 +IVA



Dimensioni	377 x 265 x 310 mm
Peso	4,7 kg
Imballo	2

## VALIGIA PORTA UTENSILI (UTENSILI NON INCLUSI)

0680



**€ 65,50**  
+ IVA

INVECE DI  
€ 119,00 +IVA



Dimensioni	510 x 375 x 185h mm
Peso	5,8 kg
Porta attrezzi	2pz

## VALIGIA PORTA UTENSILI (UTENSILI NON INCLUSI)

0681



**€ 62,00**  
+ IVA

INVECE DI  
€ 102,00 +IVA



Dimensioni	440 x 390 x 185h mm
Peso	5,2 kg
Porta attrezzi	5,2 kg

## VALIGETTA PER UTENSILI (UTENSILI NON INCLUSI)

C648



**€ 26,50**  
+ IVA

INVECE DI  
€ 48,00 +IVA



Dimensioni	510 x 280 x 220h mm
------------	---------------------

### VALIGIA RESISTENTE ALL'ACQUA



Codice	Dimensioni esterne	Listino €	Netto €
M138	465 x 360 x 175h mm	57,50	35,50
M139	570 x 410 x 215h mm	79,00	47,50

### BORSA PORTA UTENSILI

0390



**€ 25,00**  
+ IVA

INVECE DI  
€ 39,00 +IVA



Tasche	14
Dimensioni	400 x 225 x 250h mm
Materiale	Plyester 1980 denari / denier

### VALIGIA PORTA UTENSILI CON CARRELLO (UTENSILI NON INCLUSI)

0683



**€ 76,50**  
+ IVA

INVECE DI  
€ 145,00 +IVA



Dimensioni	460 x 330 x 190h mm
Peso	2,9 kg
Porta attrezzi	5,2 kg

### VALIGIA PORTA UTENSILI (UTENSILI NON INCLUSI)

0682



**€ 44,00**  
+ IVA

INVECE DI  
€ 85,00 +IVA



Dimensioni	460 x 330 x 150h mm
Peso	2,9 kg
Porta attrezzi	1pz

### BORSA PORTA UTENSILI

0395



**€ 31,00**  
+ IVA

INVECE DI  
€ 48,00 +IVA



Tasche	19
Dimensioni	480 x 250 x 225h mm
Materiale	Polyester 1680 denari

### CARRELLO PORTA UTENSILI

C900/B



**€ 277,00**  
+ IVA

INVECE DI  
€ 445,00 +IVA



Dimensioni	685 x 455 x 850h mm
Portata cassetto	25 kg
Peso	48 kg



# FERRAMENTA

## CARRELLO PORTA UTENSILI

C902/B



€ 185,00  
+ IVA

INVECE DI  
€ 300,00 +IVA



Dimensioni del vano	575 x 430 x 315h mm
Dimensioni	680 x 435 x 780h mm
Portata cassetto	25 kg

## SET 3 BAULI IN ALLUMINIO

0849



€ 109,00  
+ IVA

INVECE DI  
€ 210,00 +IVA



Dimensioni bauli	730 x 380 x 360h mm - 680 x 310 x 320h mm - 475 x 260 x 210h mm
Peso	15 kg

## CARRELLO PORTA UTENSILI

C087



€ 115,00  
+ IVA

INVECE DI  
€ 198,00 +IVA



Dimensioni	580 x 360 x 690h mm
Dimensioni imballo	585 x 365 x 775h mm
Peso	14 kg

## SET 2 BAULI CARRELLATI PORTA UTENSILI

C081



€ 100,00  
+ IVA

INVECE DI  
€ 182,00 +IVA



Dimensioni baule piccolo con 2 vassoi mobili	610 x 375 x 415h mm
Dimensioni baule grande	750 x 487 x 493h mm

## CARRELLO GOMMATO

C1102



€ 36,00  
+ IVA

INVECE DI  
€ 80,00 +IVA



Ruote pneumatiche	Ø 260 x 85 mm
Portata	200 kg
Dimensioni pala	450 x 200 mm

## CARRELLO A 3 VASCHE

C750



€ 150,00  
+ IVA

INVECE DI  
€ 245,00 +IVA



Dimensioni	940 x 600 x 870h mm
Spessore lamiera	2,3 mm
Ruote	Ø 150 mm

### CARRELLO A 3 VASCHE

C650



**€ 93,00**  
+ IVA

INVECE DI  
€ 149,00 +IVA



Dimensioni	800 x 450 x 800h mm
Spessore lamiera	1,5 mm
Ruote	ø 80 mm

### CARRELLO GOMMATO

C182



**€ 97,00**  
+ IVA

INVECE DI  
€ 160,00 +IVA



Ruote pneumatiche	Ø 260 x 85 mm
Portata	200 kg
Dimensioni pala	308 x 208 mm

### CARRELLO MULTIUSO

C189



**€ 48,00**  
+ IVA

INVECE DI  
€ 79,00 +IVA



Ruote pneumatiche	Ø 260 x 85 mm
Portata	150 Kg
Dimensioni pala	400 x 250 mm

### SGABELLO PER OFFICINA

0645/S



**€ 27,00**  
+ IVA

INVECE DI  
€ 47,00 +IVA



Dimensioni	368 x 360 x 365 mm
Peso	3,8 kg

### CARRELLO CON PIATTAFORMA IN PVC

C150



**€ 36,00**  
+ IVA

INVECE DI  
€ 59,00 +IVA



Ruote gommatae	Ø 100 mm
Portata	150 kg
Dimensioni piattaforma	700 x 450 mm

### CARRELLO SOTTAUTO A 6 RUOTE

0645/C



**€ 32,00**  
+ IVA

INVECE DI  
€ 53,00 +IVA



Dimensioni	1030 x 420 x 110h mm
Peso	6,5 kg



# FERRAMENTA

## CARRELLO SOTTAUTO IN PLASTICA

0645/CP

**€ 34,50**  
+ IVA

INVECE DI  
€ 59,00 +IVA



Dimensioni	1000 x 470 x 120h mm
Peso	5,5 kg

## CARRELLO SGABELLO SOTTAUTO 2 IN 1

0645/CS

**€ 55,00**  
+ IVA

INVECE DI  
€ 88,00 +IVA



Dimensioni carrello	1030 x 420 x 125h mm
Dimensioni sgabello	630 x 420 x 410h mm
Peso	11 kg

## CARRELLO COMPLETO DI UTENSILI

C960C

**€ 683,00**  
+ IVA

INVECE DI  
€ 990,00 +IVA



Completo di utensili	289 pz
Dimensioni	730 x 510 x 1100h mm
Peso	100 kg

## CARRELLO A 7 CASSETTI COMPLETO DI UTENSILI

C190C

**€ 699,00**  
+ IVA

INVECE DI  
€ 1.190,00 +IVA



Dimensioni	724 x 470 x 1032 mm
Peso	92,7 kg
Utensili	152pz sistema antiribaltamento

## VALIGETTA CON UTENSILI ED ACCESSORI

0165

**€ 156,00**  
+ IVA

INVECE DI  
€ 240,00 +IVA



Peso	15,5 kg
Utensili e accessori	150 pz
Cromo Vanadio	

## VALIGETTA CON UTENSILI E ACCESSORI

0315

**€ 105,00**  
+ IVA

INVECE DI  
€ 164,00 +IVA



Peso	9,5 kg
Utensili e accessori	132 pz
Cromo Vanadio	

### GENERATORE AD INVERTER

GI01/11



**€ 590,00**  
+ IVA

INVECE DI  
€ 1.030,00 +IVA



Potenza massima	1,1 kVA
Potenza nominale in corrente alternata	0,9 kVA
Frequenza	50 Hz

### GENERATORE AD INVERTER

GI01/20



**€ 780,00**  
+ IVA

INVECE DI  
€ 1.350,00 +IVA



Potenza massima	2 kVA
Potenza nominale in corrente alternata	1,6 kVA
Potenza nominale in corrente continua	12 V / 8,3 A

### GENERATORE AD INVERTER

GI01/32



**€ 980,00**  
+ IVA

INVECE DI  
€ 1.810,00 +IVA



Potenza	230 V 50 Hz 3,2 kVA
Potenza nominale in corrente alternata	2,8 kVA
Potenza nominale in corrente continua	12V/8,3A

### FARETTO A BASSO CONSUMO ENERGETICO CON SUPPORTO

0361



**€ 47,50**  
+ IVA

INVECE DI  
€ 77,00 +IVA



Alimentazione	230 V 50 Hz 60 W
2 Lampade	E27 18 W
1 Lampada	E27 24 W

### LAMPADA A 48 LED CON LENTE

0366



**€ 59,50**  
+ IVA

INVECE DI  
€ 98,00 +IVA



Alimentazione	230 V 50 Hz 4,8 W
Ingrandimenti	2x
Lente	Ø 127 mm

### CARICA BATTERIE DIGITALE INTELLIGENTE DA 6 - 12 V - 4 A

0432



**€ 48,50**  
+ IVA

INVECE DI  
€ 81,00 +IVA



Alimentazione	220÷ 240 V 50÷ 60 Hz
Potenza	14,7 V 4 A max
Peso	500 g



# FERRAMENTA

## CARICA BATTERIE DIGITALE INTELLIGENTE DA 12 V - 2 A

0447



€ 33,50  
+ IVA

INVECE DI  
€ 60,00 +IVA



Alimentazione	220÷ 240 V, 50÷ 60 Hz
Potenza	14,4 V 4 A max
Peso	430 g

## FARETTO A LED AD ALTA POTENZA

0437



€ 13,00  
+ IVA

INVECE DI  
€ 22,00 +IVA



Batterie non incluse	4 C
Potenza LED	3 W
Autonomia	25 h / 100 %

## TORCIA IMPERMEABILE A LED

0436



€ 10,00  
+ IVA

INVECE DI  
€ 16,00 +IVA



Batterie non incluse	4 AA
Potenza LED	3 W
Peso	200 g

## LAMPADA RICARICABILE CON TECNOLOGIA LED COB

0401



€ 49,00  
+ IVA

INVECE DI  
€ 80,00 +IVA



Alimentazione	100÷ 240 V , 50÷ 60 Hz
Batteria	3,7 V 2 x 2000 mAh Lithium
Tempo di ricarica	6 h

## PORTALAMPADA CON CAVO DI ALIMENTAZIONE DI 5 m

0429



€ 13,00  
+ IVA

INVECE DI  
€ 23,00 +IVA



Lunghezza cavo	5 m
Attacco lampadina	E27
Voltaggio	12÷ 230 V

## AVVOLGICAVO



Codice	Lunghezza cavo	Listino €	Netto €
A010/25	25 m	70,00	40,00
A010/50	50 m	125,00	70,00

**AVVOLGICAVO AUTO-RIENTRANTE CON PORTALAMPADA**
**0428**

**€ 58,50**  
+ IVA

 INVECE DI  
€ 95,00 +IVA

Lunghezza cavo	13 + 1 m
Attacco lampadina	E27
Voltaggio	12÷ 230 V

**SALDATORE A PISTOLA MULTIFUNZIONE**
**0443**

**€ 29,00**  
+ IVA

 INVECE DI  
€ 48,00 +IVA

Alimentazione	220÷240V 50Hz 200W
Temperatura	70°C ÷ 500°C
Peso	1350 g

**COLTELLO A CALDO TAGLIA POLISTIROLO CON TEMPERATURA REGOLABILE**
**0441**

**€ 38,00**  
+ IVA

 INVECE DI  
€ 60,00 +IVA

Alimentazione	220÷ 240 V, 50 Hz, 220 W
Temperatura	120 - 220 - 330 - 400 - 450°C
Max. spessore taglio su lamiera ferrosa	90 mm

**SVERNICIATORE DIGITALE**
**0444**

**€ 43,00**  
+ IVA

 INVECE DI  
€ 72,20 +IVA

Alimentazione	220 V, 50 Hz, 2000 W
Temperatura	I 50°C II 70°C÷ 600°C III 70°C÷ 600°C
Flusso d'aria	I 300L/min II 300L/min III 500L/min

**PISTOLA TERMOCOLLANTE AUTOMATICA**
**0431**

**€ 9,00**  
+ IVA

 INVECE DI  
€ 15,00 +IVA

Alimentazione	220 V, 35 W, 200°C
Colla in stick	Ø 12 mm
Flusso colla	16÷ 20 g/min

**MINI SMERIGLIATRICE PNEUMATICA ASSIALE**
**0413**

**€ 18,00**  
+ IVA

 INVECE DI  
€ 29,00 +IVA

Pinze	Ø 3 mm e 6 mm
Velocità	25000 rpm
Consumo aria stimato	4 CFM (113 l/min)





# FERRAMENTA

## SMERIGLIATRICE PNEUMATICA ASSIALE LUNGA

0417



€ 33,00  
+ IVA

INVECE DI  
€ 53,00 +IVA



Pinze	Ø 3 mm e 6 mm
Lunghezza	295 mm
Velocità	20000 rpm

## SMERIGLIATRICE PNEUMATICA A 90°

0416



€ 32,00  
+ IVA

INVECE DI  
€ 52,00 +IVA



Pinze	Ø 3 mm e 6 mm
Velocità	20000 rpm
Consumo aria stimato	4 CFM (113l/min)

## SMERIGLIATRICE PNEUMATICA ASSIALE

0414



€ 20,00  
+ IVA

INVECE DI  
€ 33,00 +IVA



Pinze	Ø 3 mm e 6 mm
Velocità	22000 rpm
Consumo aria stimato	7 CFM (198 l/min)

## LEVIGATRICE PNEUMATICA ROTORBITALE DA 150 mm CON ASPIRAZIONE

0419



€ 54,00  
+ IVA

INVECE DI  
€ 86,00 +IVA



Diametro disco	150 mm - 6"
Orbita	5 mm, 3/16"
Velocità	10500 rpm MAX.

## LEVIGATRICE PNEUMATICA ROTORBITALE DA 150 mm CON ASPIRAZIONE INTEGRATA

0421



€ 58,00  
+ IVA

INVECE DI  
€ 93,50 +IVA



Diametro disco	150 mm - 6"
Orbita	5 mm, 3/16"
Velocità	10500 rpm MAX.

## LEVIGATRICE PNEUMATICA ROTORBITALE 150 mm CON ASPIRAZIONE

0458



€ 54,00  
+ IVA

INVECE DI  
€ 86,00 +IVA



Diametro disco	150 mm - 6"
Orbita	2,5 mm - 3 / 32"
Velocità max di utilizzo	10500 rpm

### CALIBRO ELETTRONICO DIGITALE INOX

ART. C031/150



**€ 95,00**  
+ IVA

INVECE DI  
€ 150,00 +IVA



Utile	0 ÷ 150 mm - 0 ÷ 6 inch
Lettura	0,01 mm - 0.0005 inch
Becchi	40

### CALIBRO ELETTRONICO DIGITALE INOX



Codice	Utile	Listino €	Netto €
C033/150	0÷ 150 mm - 0÷ 6 inch	55,00	31,50
C033/200	0÷ 200 mm - 0÷ 8 inch	80,00	48,00
C033/300	0÷ 300 mm - 0÷ 12 inch	120,00	72,50

### CALIBRO MONOBLOCCO INOX CROMATO OPACO

ART. C018/200



**€ 22,50**  
+ IVA

INVECE DI  
€ 55,00 +IVA



Utile	0÷ 200 mm - 0÷ 8 inch
Lettura	1/50 0,02 mm - 1/1000 inch
Becchi	50

### CALIBRO SATINATO



Codice	Utile	Listino €	Netto €
C020/1000	0÷ 1000 mm	365,00	190,00
C020/500	0÷ 500 mm	145,00	60,00

### CALIBRO MONOBLOCCO SATINATO INOX



Codice	Utile	Listino €	Netto €
C021/300	0÷ 300 mm - 0÷ 12 inch	155,00	62,00
C021/500	0÷ 500 mm - 0÷ 20 inch	215,00	99,00

### RIGA CON DISPLAY DIGITALE MULTIFUNZIONE



Codice	Lunghezza totale	Listino €	Netto €
R060	600 mm - 24" inch	80,00	40,00
R100	1000 mm - 40" inch	105,00	58,00



# STRUMENTI DI MISURA

## GONIOMETRO DIGITALE E LIVELLA CON 2 FIALE

ART. G008

**€ 27,00**  
+ IVA

INVECE DI  
€ 45,00 +IVA



Lunghezza	400 mm
Scala	0÷ 225°
Letture	0,1°

## COMPARATORE CENTESIMALE + SUPPORTO MAGNETICO PORTA COMPARATORE

ART. C023

ART. S046



## VENDITA ABBINATA

**€ 58,00 + IVA**

INVECE DI € 138,00 +IVA



Diametro quadrante	60 mm
Campo di misura	10 mm
Letture	0,01 mm

## COMPARATORE CENTESIMALE

ART. C002

**€ 28,00**  
+ IVA

INVECE DI  
€ 46,70 +IVA



Diametro quadrante	60 mm
Campo di misura	10 mm
Letture	0,01 mm

## INDICATORE A TASTO CENTESIMALE

ART. T003

**€ 41,50**  
+ IVA

INVECE DI  
€ 91,00 +IVA



Diametro quadrante	32 mm
Campo di misura	0,8 mm
Letture	0,01 mm

## AZZERZATORE CON COMPARATORE CON BASE MAGNETICA

ART. A020

**€ 75,00**  
+ IVA

INVECE DI  
€ 123,00 +IVA



Altezza di azzeramento	50 mm
Letture	0,01 mm
Utile	0 ÷ 8 mm

## CENTRATORE A 2 ASSI

ART. C061

**€ 132,50**  
+ IVA

INVECE DI  
€ 230,00 +IVA



Comparatore	Ø 40 mm
Corsa max	4,9 mm
Letture	0,01 mm

### SUPPORTO MAGNETICO PORTA COMPARATORE

ART. S049



**€ 15,00**  
+ IVA

INVECE DI  
€ 33,00 +IVA



Asta principale	Ø 12 x 170 mm
Asta secondaria	Ø 10 x 140 mm
Forza	60 kg

### SQUADRA MAGNETICA A 90°

ART. S045



**€ 32,00**  
+ IVA

INVECE DI  
€ 70,00 +IVA



Asta principale	Ø 12 x 160 mm
Asta secondaria	Ø 10 x 125 mm
Forza	60 kg

### SQUADRA MAGNETICA A 90°



Codice	Dimensioni	Listino €	Netto €
S056/150	150 x 150 x 50 mm	72,00	43,50
S056/200	200 x 200 x 50 mm	90,00	56,50

### SQUADRA MAGNETICA INCLINABILE

ART. S058



**€ 50,00**  
+ IVA

INVECE DI  
€ 83,00 +IVA



Dimensioni	115 x 115 x 35 mm
Gradi	45° ÷ 90°
Forza magnetica	250 N

### LASER AUTOLIVELLANTE

ART. 0646/A



**€ 55,70**  
+ IVA

INVECE DI  
€ 98,50 +IVA



Precisione di livellamento	0,5 mm / m
Precisione linea orizzontale e verticale	± 0,5 mm / m
Batteria	3 x 1,5V AA

### MINI LIVELLA LASER

ART. 0449



**€ 13,00**  
+ IVA

INVECE DI  
€ 22,00 +IVA



Tipo laser	Classe II / 650 nm
Distanza di lavoro	20 m
Potenza	≤ 1 mW



# STRUMENTI DI MISURA

## LIVELLA DIGITALE CON RAGGIO LASER

ART. 0666

**€ 94,50**  
+ IVA

INVECE DI  
€ 155,00 +IVA



Lunghezza	600 mm
Autospegnimento	5 min
Gamma di misurazione	0 ~ 360°

## ENDOSCOPIO FLESSIBILE PER MECCANICA

ART. E023/5

**€ 390,00**  
+ IVA

INVECE DI  
€ 595,00 +IVA



Lunghezza senza manico	1000 mm
Sonda	Ø 5,5 mm
Zoom digitale	4 X

## PINZA AMPEROMETRICA DIGITALE

ART. E022/12

**€ 190,00**  
+ IVA

INVECE DI  
€ 340,00 +IVA



Lunghezza senza manico	900 mm
Sonda	Ø 12 mm
Visione	0° - 60°

## PINZA AMPEROMETRICA DIGITALE

ART. P075

**€ 72,00**  
+ IVA

INVECE DI  
€ 125,00 +IVA



ACV	750 V ±1,2 %
ACA	200 - 1000 A ±2,0 %
DCV	1000 V ±1,0 %

## PINZA AMPEROMETRICA DIGITALE

ART. P080

**€ 43,00**  
+ IVA

INVECE DI  
€ 69,00 +IVA



ACV	4/40/400/600 V ±1,5 % + 4
ACA	4/40/400/600 A ±1,5 % + 4
DCV	4/40/400/600 V ±1,0 % + 2

## MULTIMETRO DIGITALE TASCABILE

ART. T051

**€ 9,50**  
+ IVA

INVECE DI  
€ 17,50 +IVA



DCV	2-20-200-500V ±0,5%
ACV	200-500V ±1,2%
DCA	200mA ±1,5%

**MULTIMETRO DIGITALE**
**ART. T053**

**€ 52,00**  
+ IVA

 INVECE DI  
€ 85,00 +IVA

DCV	2 V - 20 V - 200 V - 500 V ±0,5%
ACV	200 V - 500 V ±1,2%
DCA	200 mA ±1,5%

**MISURATORE DI DISTANZA AD ULTRASUONI**
**ART. M035**

**€ 29,50**  
+ IVA

 INVECE DI  
€ 48,00 +IVA

Campo di misura	0,9÷ 18,30 m / 3÷ 60 piedi - Ft
Lettura	0,01 m / 0,5 pollici - inch
Precisione	0,5% ±1 cifra / ±1 digit

**MISURATORE DI TEMPERATURA AD INFRAROSSI CON PUNTATORE LASER**
**ART. T068**

**€ 76,50**  
+ IVA

 INVECE DI  
€ 170,00 +IVA

Campo di misura	-30°C÷ 550 °C / -22 °C÷ 1022 °F
Precisione	-30 °C÷ 0 °C (-22 °F÷ 32 °F) ±3 % o ±3 °C
Precisione	0 °C÷ 100 °C ( 32 °F÷ 212 °F) ±2 % o ±2 °C

**MISURATORE DI TEMPERATURA AD INFRAROSSI CON PUNTATORE LASER**
**ART. T064**

**€ 55,00**  
+ IVA

 INVECE DI  
€ 95,00 +IVA

Campo di misura	-25°C÷ 400 °C / -13 °C÷ 752 °F
Precisione	-25 °C÷ 400 °C ±(2 % + 1 °C)
Precisione	-13° F÷ 752°F ±(2 % +1 °F)

**MISURATORE DI TEMPERATURA DIGITALE TASCABILE**
**ART. T054**

**€ 15,00**  
+ IVA

 INVECE DI  
€ 35,00 +IVA

Lettura	1° C
Campo di misura	-50°C÷1200°C / -50°C÷250°C per uso con T056/TP01 -50°C÷750°C per uso con T056/TP02

**MISURATORE DI TEMPERATURA DIGITALE PORTATILE**
**ART. T063**

**€ 35,00**  
+ IVA

 INVECE DI  
€ 59,00 +IVA

Lettura	1° C
Campo di misura	-50°C÷250°C per uso con T056/TP01 -50°C÷750°C per uso con T056/TP02



# STRUMENTI DI MISURA

## MISURATORE DI TEMPERATURA DIGITALE PORTATILE

ART. T055



€ 77,00  
+ IVA

INVECE DI  
€ 128,00 +IVA



<b>Campo di misura</b>	-50°C÷1300°C -50°C÷750°C per uso con T056/TP02
<b>Letture</b>	0,1 °C (sotto i 1000 °C) 0,1 °F ( less than 1000 °C)

## LUXMETRO DIGITALE

ART. L014



€ 37,00  
+ IVA

INVECE DI  
€ 68,30 +IVA



<b>Campo di misura</b>	0 LUX÷ 2000 LUX
<b>Risoluzione</b>	1 LUX
<b>Precisione</b>	± 5 %

## RILEVATORE DIGITALE

ART. 0387



€ 40,00  
+ IVA

INVECE DI  
€ 65,00 +IVA



<b>Massima profondità di rilevazione</b>	
<b>Metalli ferrosi</b>	60 mm
<b>Metalli non ferrosi</b>	50 mm

## CERCAMETALLI

ART. MD01



€ 68,00  
+ IVA

INVECE DI  
€ 112,00 +IVA



<b>Diametro bobina</b>	170 mm
<b>Connettore jack</b>	1/4"
<b>Sensibilità</b>	> 15 cm per una moneta di ø 25 mm

## CONTAGIRI DIGITALE OTTICO E A CONTATTO

ART. C070



€ 90,00  
+ IVA

INVECE DI  
€ 180,00 +IVA



<b>Velocità di rotazione ottica</b>	2,5÷ 9999,9 rpm
<b>Velocità di rotazione contatto</b>	0,05÷ 999,9 rpm
<b>Velocità tangenziale</b>	0,1÷ 999,99 m / min

## CONTAGIRI DIGITALE OTTICO

ART. C067



€ 50,50  
+ IVA

INVECE DI  
€ 105,00 +IVA



<b>Campo di misura</b>	2,5÷ 9999,9 rpm
<b>Letture</b>	0,1 (2,5÷ 999,9) rpm
<b>Letture</b>	1 (1000÷ 9999,9) rpm

**RIFRATTOMETRO**
**ART. 0433**
**€ 44,00**  
+ IVA

 INVECE DI  
€ 78,00 +IVA

Campo di misura	0÷ 32% Brix
Letture	± 0.2%

**RIFRATTOMETRO BRUX**
**ART. 0583**
**€ 46,50**  
+ IVA

 INVECE DI  
€ 85,00 +IVA

Campo di misura	0÷ 80 % Brix
Letture	1 % Brix

**RIFRATTOMETRO**
**ART. 0312**
**€ 46,50**  
+ IVA

 INVECE DI  
€ 85,00 +IVA

Scala per liquidi antigelo E	-50 °C÷ 0 °C lettura 1°C
Scala per liquidi antigelo P	-50 °C÷ 0 °C lettura 1°C
Scala per liquidi batteria B	1,10÷ 1,40 sg lettura 0,01 sg

**BILANCIA ELETTRONICA DIGITALE CON DOPPIO DISPLAY**
**ART. B018**
**€ 70,00**  
+ IVA

 INVECE DI  
€ 120,00 +IVA

Capacità	30 kg
Letture	10 g
Dimensione piatto	340 x 230 mm

**BILANCIA ELETTRONICA DIGITALE CONTAPEZZI RICARICABILE**

Codice	Capacità	Listino €	Netto €
B004/7	7,5 kg	375,00	203,00
B004/30	30 kg	375,00	203,00

**DINAMOMETRI DIGITALI**

Codice	Grandezza caratteri	Listino €	Netto €
D012/0500	40 x 20 mm	1.090,00	650,00
D012/0300	40 x 20 mm	928,00	550,00